

Products > Sapphire Windows > Circular Sapphire Windows > W11.11

Circular Sapphire Windows - W11.11

Specifications

Model	W11.11
Diameter	.433/.441"
Thickness	.018/.022"
Material	Sapphire

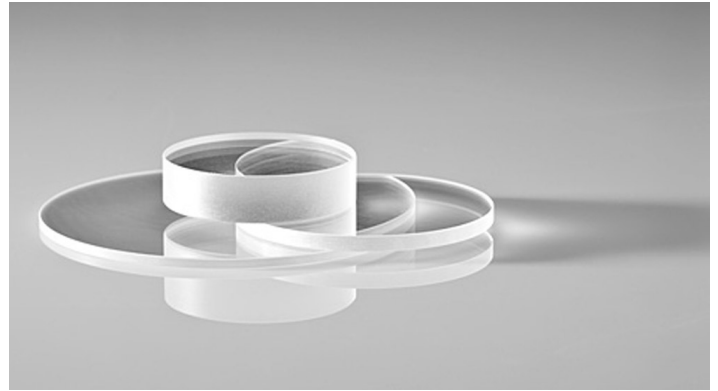

Description

Our extensive stock list includes a wide range of diameters and thicknesses. They have standard S/D 80/50 or better and random orientation. We also offer our expertise in developing precision customized sapphire windows manufactured to your project's specifications, including orientations, surface finishes and materials.

Typical Applications

- Gas & Air Analyzers/Monitors
- UV & IR Detectors, Endoscopes
- High Intensity Lamps
- Bar Code Readers
- Photodiodes
- View Ports

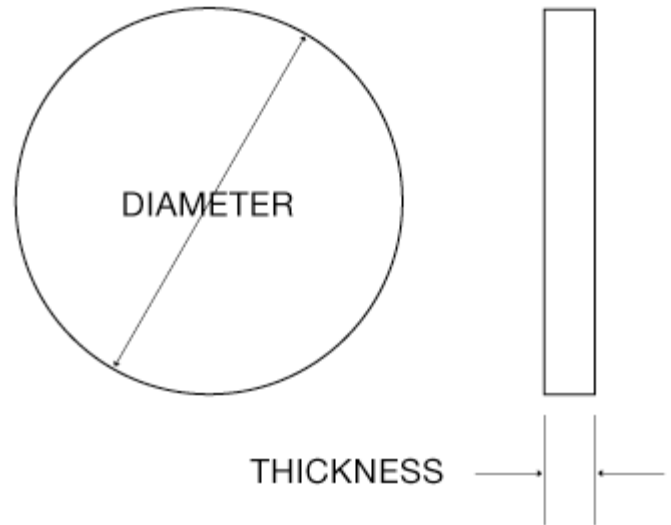

NOT SEEING EXACTLY WHAT YOU NEED?

We specialize in creating a wide range of custom optical components and custom mechanical components including a variety of shapes - from internal holes and tapers to outer flanges, angles and surface finishes. Contact us and we will consult with you to create a custom component that meets all of your specifications.